

BAXI FIRES DIVISION

OWNER GUIDE

Model 741

INSET LIVE FUEL EFFECT GAS FIRE

Fitted with

Blenheim

or

Sonnet fascia



(GC No. 32-032-56)

**THIS APPLIANCE IS FOR USE WITH NATURAL GAS (G20).
WHEN CONVERTED USING CONVERSION KIT NO. 0595211 THIS APPLIANCE
IS FOR USE WITH PROPANE GAS (G31).
THIS APPLIANCE IS SUITABLE ONLY FOR INSTALLATION IN THE UNITED
KINGDOM (GB) AND THE REPUBLIC OF IRELAND (IE).**

We trust that this guide gives sufficient details to enable your appliance to be operated and maintained satisfactorily. However, if further information is required, our **Baxi Fires Division Technical Helpline** will be pleased to help. **Please telephone 08706 061 065** (National call rates apply in the United Kingdom). In the Republic of Ireland telephone **0044 8706 061 065**.

This guide is intended to help you care for your Baxi Fires Division gas fire. Please read thoroughly before using and keep for future reference.

This guide to be left with the owner.

BAXI • VALOR • WONDERFIRE

OWNER GUIDE

Safety First.

Baxi Fires Division fires are CE Approved and designed to meet the appropriate British Standards and Safety Marks.



Quality and Excellence.

At the heart of every Baxi Fires Division fire.

All Baxi Fires Division fires are manufactured to the highest standards of quality and excellence and are manufactured under a BS EN ISO 9001 quality system accepted by the British Standards Institute.



The Highest Standards

Baxi Fires Division is a member of the Society of British Gas Industries which works to ensure high standards of safety, quality and performance.



Careful Installation

Baxi Fires Division is a CORGI registered company. All our gas fires must be installed by a competent CORGI Registered Installer in accordance with our Installer Guide and should not be fitted directly on to a carpet or floor of combustible material.

B A X I F I R E S D I V I S I O N

Baxi Fires Division, Erdington, Birmingham B24 9QP

www.firesandstoves.co.uk

Because our policy is one of constant development and improvement, details may vary slightly from those given in this publication

OWNER GUIDE

LIST OF CONTENTS

<u>Section</u>	<u>Page</u>
SAFETY	4
APPLIANCE DIMENSIONS	5
GAS CONSUMPTION	6
OPERATING YOUR FIRE	6
The Oxysafe flame sensing and flue blockage safety system.	6
To light the fire.	7
Lighting with a taper.	8
CLEANING YOUR FIRE	8
Metal Parts	8
Ceramic fuel effect pieces and burner compartment walls.	8
Burner.	9
CERAMIC FUEL EFFECT REFITTING	9
MAINTENANCE	12
Regular maintenance.	12
Servicing.	12
USEFUL TELEPHONE NUMBERS	12

This gas fire is designed to meet the most stringent quality, performance and safety requirements to provide you with many years' trouble-free service.

This guide aims to improve your understanding and appreciation of your gas fire by providing simple and informative instructions to ensure that you benefit from the excellent performance and features it has to offer.

OWNER GUIDE

SAFETY

IF YOU SMELL GAS

DON'T SMOKE

EXTINGUISH ALL NAKED FLAMES

DON'T TURN ELECTRICAL SWITCHES ON OR OFF

TURN OFF THE GAS SUPPLY AT THE METER

OPEN DOORS AND WINDOWS TO GET RID OF THE GAS

IMMEDIATELY CALL THE GAS EMERGENCY SERVICE - SEE YOUR LOCAL TELEPHONE DIRECTORY

Do have the fire installed by a competent person. In the United Kingdom, installation must be in accordance with the latest edition of the Gas Safety (installation & use) Regulations. In the Republic of Ireland, installation must be in accordance with all national and local regulations in force.

Do have the chimney swept prior to installation if it was previously used for solid fuel.

Do have the fire installed in accordance with the installer guide.

Do allow a minimum clearance of 760 mm from the top of the base of the hotbox to the underside of any shelf whether it is made from combustible or non-combustible materials. For a shelf made from wood or other combustible materials deeper than 150mm add 12.5mm to the clearance for every 25mm of additional shelf depth (See graph 1). Please bear this in mind if ever you add a shelf.

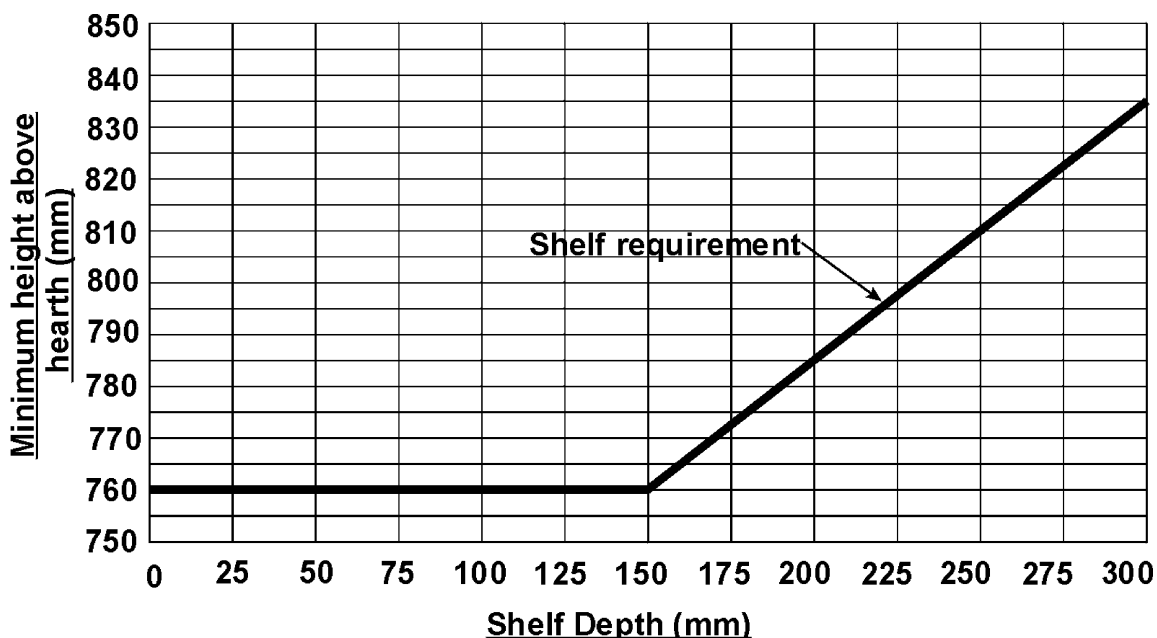

Graph 1. Combustible shelf clearances.

OWNER GUIDE

Do provide a suitable guard that complies with BS 8423 for the protection of young children, the elderly and the infirm. Such a guard is also recommended for the protection of pet animals. (Although this fire conforms to all the applicable standards, it is a heating appliance and certain parts of its surface will become hot).

Do wait three minutes before attempting to relight if the fire is switched off or the flames are extinguished for any reason. (Your fire is fitted with a safety device that will automatically shut off the gas supply to the fire if, for any reason, the flames go out).

Do get advice about the suitability of any wall covering near your fire. Soft wall coverings (e.g. embossed vinyl, etc.) which have a raised pattern are easily affected by heat. They may, therefore, scorch or become discoloured when close to a heating appliance. Please bear this in mind whenever you are considering redecorating.

Do provide a minimum side clearance as detailed in figure 1. Please bear this in mind if ever you are considering altering the room.

Don't hang clothing, towels or any other fabrics over the fire.

Don't add any extra fuel effect pieces above the number stated in this guide. This could cause a safety hazard.

Don't put paper or any other material on the fire.

Don't place any combustible material (rugs, carpet, plastic tiles, etc.) on the hearth.

Don't attempt to clean or service the fire until it has been switched off and allowed to cool completely.

APPLIANCE DIMENSIONS

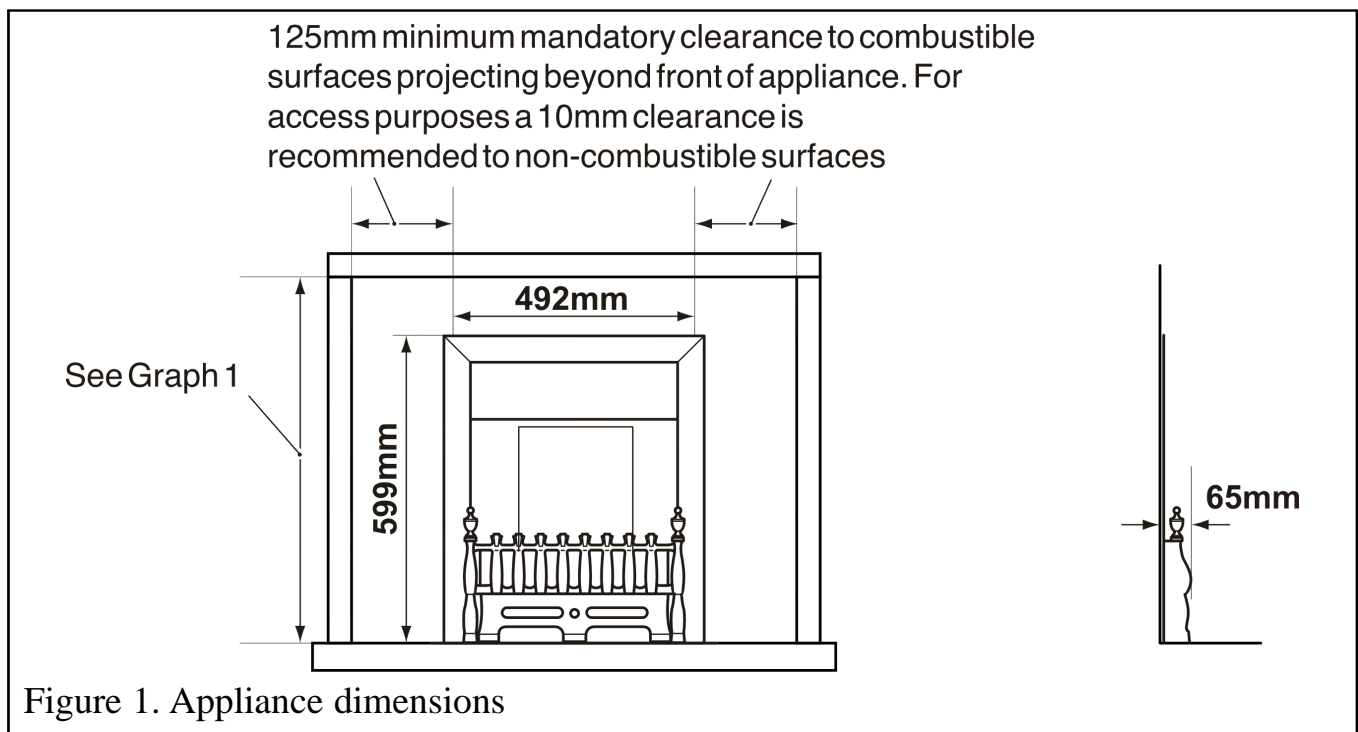

OWNER GUIDE

GAS CONSUMPTION

Model 741

Has a maximum natural gas input of 6.85kW (Gross)

Has a maximum natural gas output of 3.4kW

Has a minimum natural gas input of 2.3kW (Gross)

Has a minimum natural gas output of 0.09kW

Model 741 when converted using kit number 0595211

Has a maximum propane gas input of 6.7kW (Gross)

Has a maximum propane gas output of 3.71kW

Has a minimum propane gas input of 4.0kW (Gross)

Has a minimum propane gas output of 2.10kW

OPERATING YOUR FIRE

PLEASE NOTE

When operating your fire for the first time, some vapours may be given off which may cause a slight odour and could possibly set off any smoke alarms in the immediate vicinity. These vapours are quite normal with new appliances. They are totally harmless and will disappear after a few hours use.

The Oxysafe flame sensing and flue blockage safety system.

For your safety, this appliance is fitted with a flue blockage safety device which will shut down the appliance in the event of abnormal flue conditions. *This device is NOT a substitute for an independently mounted Carbon Monoxide detector.*

The device will also automatically shut off the gas supply to the fire if the pilot flame goes out due to lack of oxygen or for any other reason.

If this device starts to repeatedly shut off the gas, get expert advice.

This device incorporates a probe which senses that the heat from the pilot flame is correct. If this probe is cool, the device will prevent any gas flow unless the control knob is held in at the ignition position.

If, for any reason, the flames go out when the fire is hot or if the fire is turned off when hot, always *wait at least three minutes before attempting to relight.*

OWNER GUIDE

To light the fire.

Depress the control knob and rotate it anticlockwise to the pilot ignition position. A 'click' will be heard as the integral piezo operates. A flame should appear at the pilot. Keep the control knob depressed and hold the pilot ignition position for five seconds. When the control knob is released the pilot flame should remain lit. If a flame does not appear at the pilot then turn the control knob clockwise to the 'OFF' position and repeat the above.

When the pilot burner is operating properly, gradually turn the control knob anticlockwise to 'HIGH' position. (Depress the knob slightly to get past the pilot ignition position). The main burner should now light.

Depress the control knob slightly to release from the 'HIGH' position and turn back (clockwise) to 'LOW'. While turning, the burner flames should gradually become lower but remain alight.

Depress the control knob slightly to release from the 'LOW' position and turn back (clockwise) to the Pilot ignition position. The main burner should extinguish but the pilot should remain alight. Depress the control knob slightly and turn back (clockwise) to turn OFF. This will extinguish the pilot.

While cooling, the ceramic fuel effects may make some crackling noises. This is quite normal.

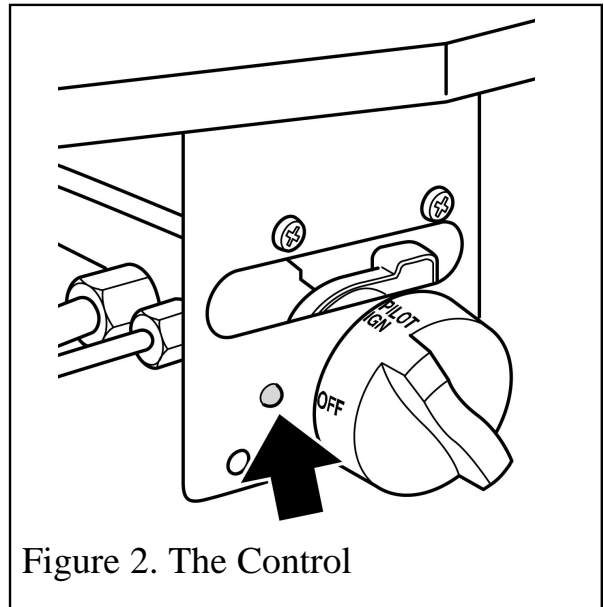

Figure 2. The Control

- Note**
- i) If the flames go out while setting the control, repeat the full lighting procedure. If the flames repeatedly go out have the fire serviced.
 - ii) Please note. When first turned on the flames will appear predominantly blue. The fuel effect pieces will take time to warm up. Although some glow will be seen after approximately ten minutes, the full visual effect will only be apparent after a somewhat longer time.
 - iii) The appliance will operate to its maximum potential if the flue is primed during the first 20 – 30 minutes of operation. To do this, simply slide the control button to its highest setting. This will also burn off any carbon deposits that may have formed during previous operations.
 - iv) If operating the appliance for long periods it is beneficial occasionally to change the settings. This will also help to remove any carbon deposits that may form during operation.

OWNER GUIDE

Lighting with a taper.

(See figure 3).

In the unlikely event of failure of the ignition spark, the pilot can be lit by a taper or long spill.

- Turn the control knob to the 'Pilot ignition' position
- Insert the taper or spill between the second and third left hand ceramic fuel effect pieces on the first row
- Depress the control knob. A flame should appear at the pilot.
- Remove the taper and keep the control depressed for 5 seconds.
- Release the control knob and the pilot flame should remain alight. If it does not, repeat the above.
- Turn the control knob to the required setting. While cooling, the ceramic fuel effect pieces may make some crackling noises. This is quite normal.

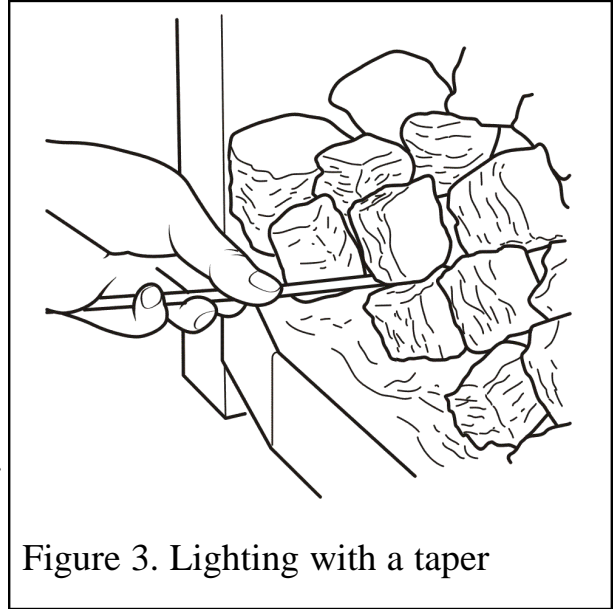

Figure 3. Lighting with a taper

CLEANING YOUR FIRE

To maintain the high performance and quality finish of your fire please follow these guidelines:

Before attempting to clean the fire, please remember to turn off the fire and wait for the appliance to cool. The fire will retain heat for some time before cleaning can begin. If any pieces of debris are found in the firebox, have the chimney inspected before further use.

Metal Parts

- Clean the metal parts with a slightly damp cloth and then dry.
- Do not use abrasive cleaners as these will scratch the fire surface.

Ceramic fuel effect pieces and burner compartment walls.

This product uses fuel effect pieces and burner compartment walls containing Refractory Ceramic Fibres (RCF), which are man-made vitreous silicate fibres. Excessive exposure to this material may cause irritation to eyes, skin and respiratory tract. Consequently, it is important to take care when handling these articles to ensure that the release of dust is kept to a minimum.

- Light coatings of soot will usually be burnt off during the normal operation of the fire. Should any soot accumulation become excessive, the fuel effect pieces and walls

OWNER GUIDE

should be removed from the fire for cleaning.

- Cleaning should be carried out in a well ventilated area or in the open air by gently brushing with the pieces held away from your face so that you avoid inhaling the dust.
- We do not recommend the use of a normal domestic vacuum cleaner which may blow dust back into the air.
- We suggest that you remove the ceramic fuel effect pieces in the reverse order to that shown in this guide.

Burner.

Remove any deposits of soot or other foreign matter from the surface of the burner with a dry soft brush. Be careful not to brush any particles into the open slots. Remove any particles from the slots with a vacuum cleaner fitted with a soft brush attachment. **Do not poke wire, etc. into the slots in the burner.**

CERAMIC FUEL EFFECT REFITTING

1. Place the ceramic base coal in the burner compartment. The bottom rear face of the coal should rest on the angled ledges at the back of the burner compartment. The bottom front recess edges on the coal base should locate against the tags at the front of the ceramic support (See figure 4).

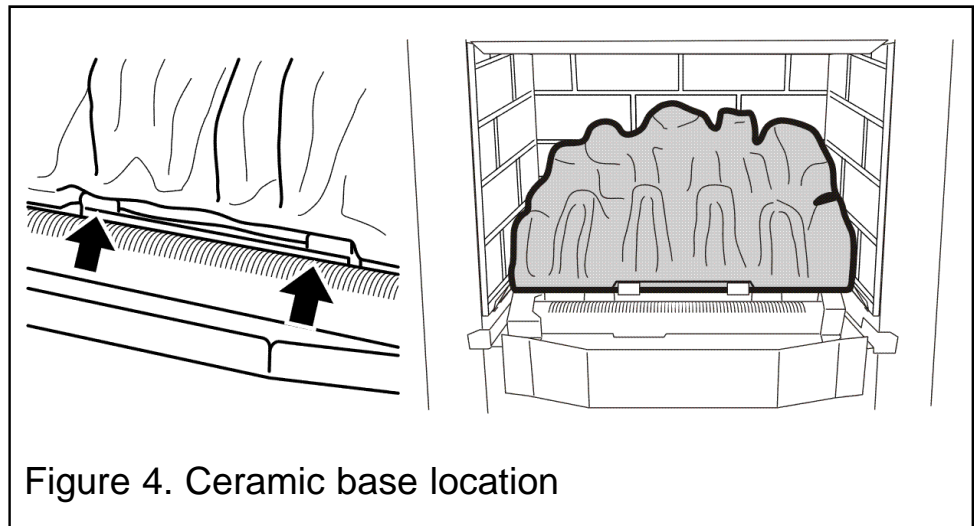

Figure 4. Ceramic base location

OWNER GUIDE

2. Place the ceramic front coal in position in front of the base coal. The front of the ceramic coal should touch the front of the burner module (See figure 5).

The loose ceramic coals are supplied in three sizes. There are two large ceramic coals, three medium ceramic coals and 12 small ceramic coals. When installing the ceramic coals smooth surfaces should be positioned to the bottom or rear unless stated otherwise. Install the loose coals as follows.

3. Locate the two large ceramic coals at the ends of the front base ceramic coal. The large ceramic coals have two sides that are smooth. Locate one smooth side along the side of the hotbox and the other to the rear (See figure 6).

4. The top surface of the front ceramic base coal has three 'V' shaped indents. Locate a small ceramic coal into each indent (See figure 6).

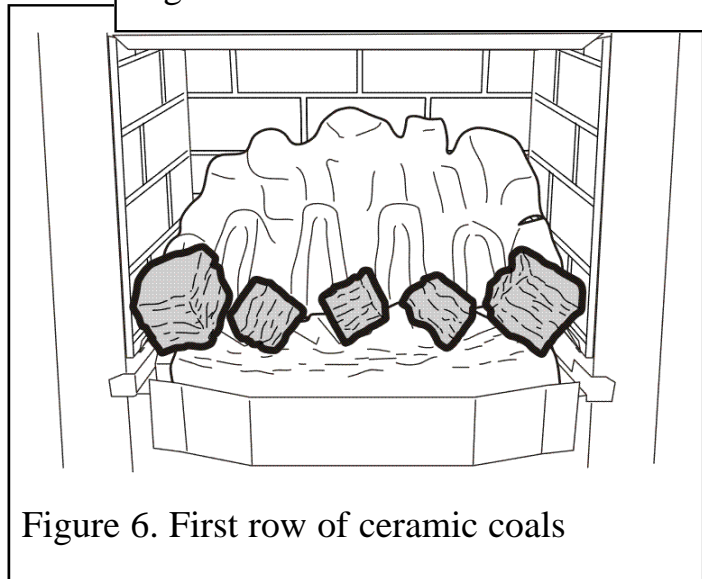
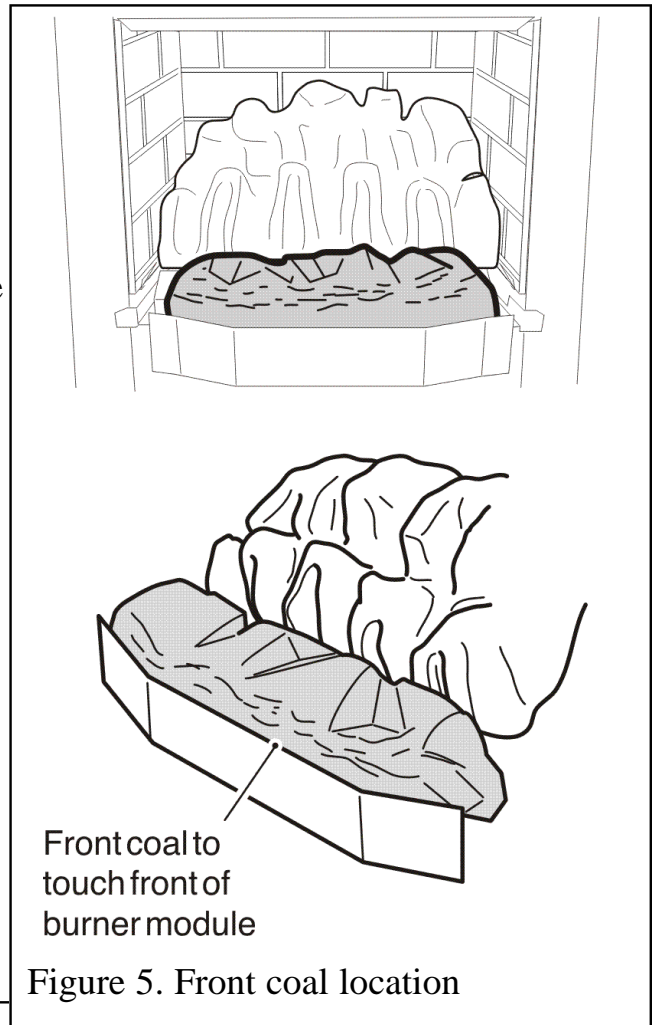

OWNER GUIDE

5. Locate four small ceramic coals into the spaces on top of the first row of ceramic coals (See figure 7).

6. Place a medium ceramic coal into the central valley in the rear ceramic base. It is important that this medium ceramic coal has a space behind it. Place a small ceramic coal each side of the medium ceramic coal. It is important that these small ceramic coals have a space behind them. (See figure 8).

7. Locate the remaining medium ceramic coals in the valley behind the two large ceramic coals on the front row (See figure 8).

8. Locate a small ceramic coal behind the central medium ceramic coal. This should be held in place between the medium ceramic coal and the ceramic base coal (See figure 9). Locate the remaining small ceramic coals each side of that located previously. These should sit behind and be held in place by the small ceramic coals in front.

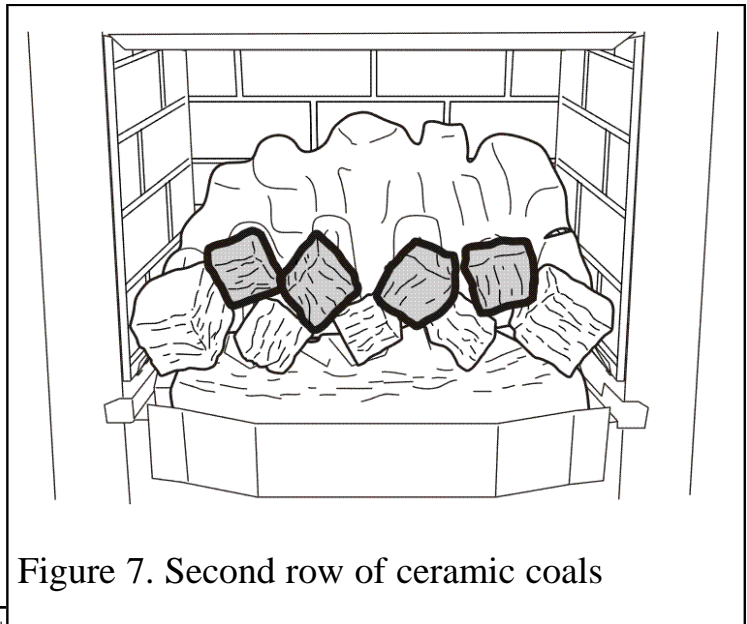

Figure 7. Second row of ceramic coals

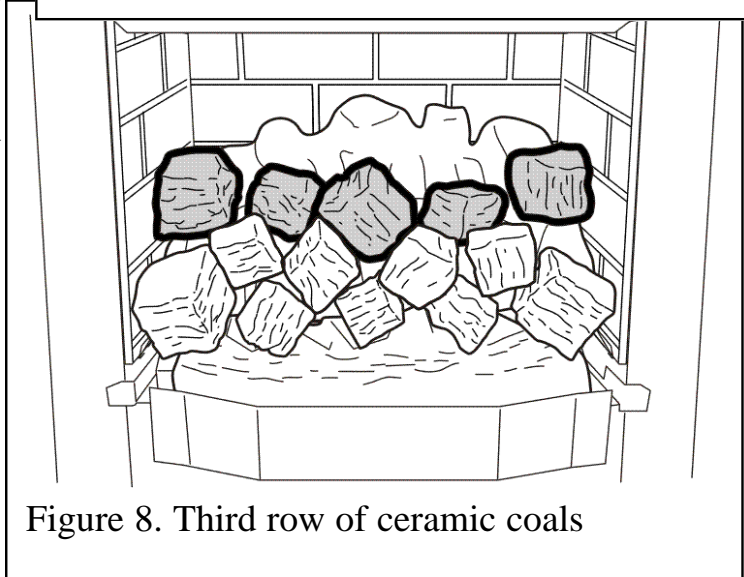

Figure 8. Third row of ceramic coals

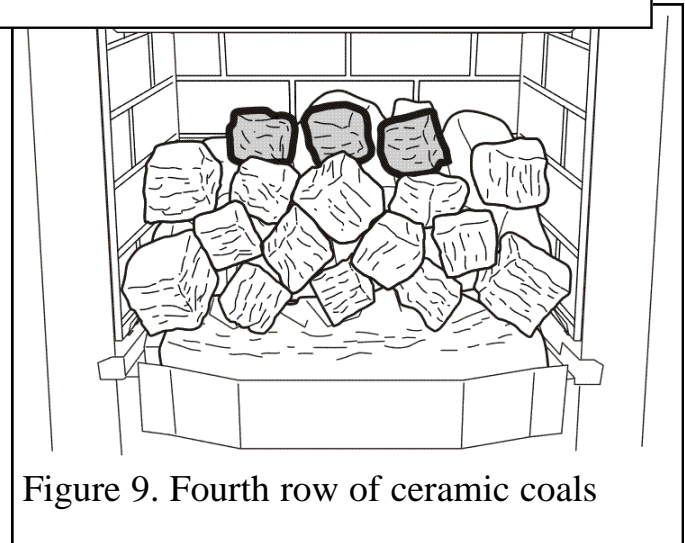

Figure 9. Fourth row of ceramic coals

OWNER GUIDE

MAINTENANCE

Regular maintenance.

In order to achieve and maintain high levels of personal safety and performance efficiency, it is essential that the opening at the back of the fire and the flue are kept clear of any form of obstruction. It is possible that deposits of mortar or soot could fall and accumulate causing the flue to be blocked or restricted and so preventing proper clearance of dangerous exhaust fumes.

In the United Kingdom it is the law that a landlord must have any gas appliance, flue and pipework which is situated in a tenant's premises checked for safety at least every twelve months by a competent person (In the U.K, a CORGI registered installer).

We recommend that all gas appliances and their flues, wherever situated, are checked annually.

Servicing.

Servicing can be carried out either by a Baxi Fires Division Service engineer or a CORGI registered installer. If you require your fire to be serviced, please contact **Baxi Fires Division Service** on **08706 090 081** and quote the following details. These can be found on a plate located below the burner and behind the lower front cover.

Type of fire.

Model/Name.

Serial Number.

You will also be asked for the fault, problem or request plus your Post Code.

USEFUL TELEPHONE NUMBERS

General advice about gas and your gas fire:

BAXI FIRES DIVISION TECHNICAL HELPLINE 08706 061 065.

To report faults or arrange for your fire to be serviced:

BAXI FIRES DIVISION SERVICE 08706 090 081.

For sales or product information:

BAXI FIRES DIVISION SALES 08706 061 067.

To order spares

Spare parts are available nationwide via the 'interpart stockist network'. For your local stockist consult Yellow pages under 'Central Heating'.

CALLERS IN THE REPUBLIC OF IRELAND

Call 0044 8706 061 065