Next



NAVIGATOR 612

PROGRAMMABLE DMX CONTROLLER

GB *USER'S MANUAL*

INDEX

We congratulate you on your purchase of NAVIGATOR 612. Before proceeding of the use of this product it should be necessary to read carefully the following user's manual to install it correctly and to make the most of its potentialities.

Sets of the equipment

- 1.1 Unpacking of the equipment
- 1.2 Accessories issued with the equipment and relative documentation

Description of the rear panel and installation

- 2.1 Description of the rear panel
- 2.2 DMX 512 output connection
- 2.3 Input connection for power supply
- 2.4 Connection of the ballast to the electric system

Use of the equipment - modes of operation

- 3.1 **PROGRAM** mode
- 3.2 **SCENE** mode
- 3.3 **MAN + PROGRAM** mode
- 3.4 **MAN + SCENE** mode

Description of the front panel

- 4.1 Description of the front panel

Use of the equipment - main functions

- 5.1 Adjustment of the **RATE** speed
- 5.2 Adjustment of the **SPEED** speed
- 5.3 Adjustment of the **X** and **Y** channels through the **Joystick**
- 5.4 Adjustment of the **IRIS - COLOUR - GOBO - SHUTTER** channels
- 5.5 **MUSIC** function
- 5.6 **BLK** function

Use of the equipment - secondary functions

- 6.1 **MEM** function
- 6.2 **COPY** function
- 6.3 **LENGTH** function
- 6.4 **REPEAT** function

Exemple of working - creation of a program

- 7.1 Creation of a program

1.1 UNPACKING OF THE EQUIPMENT

Open the box; take the ballast and the documentation out.

Take the equipment out of the box as shown in the picture below.

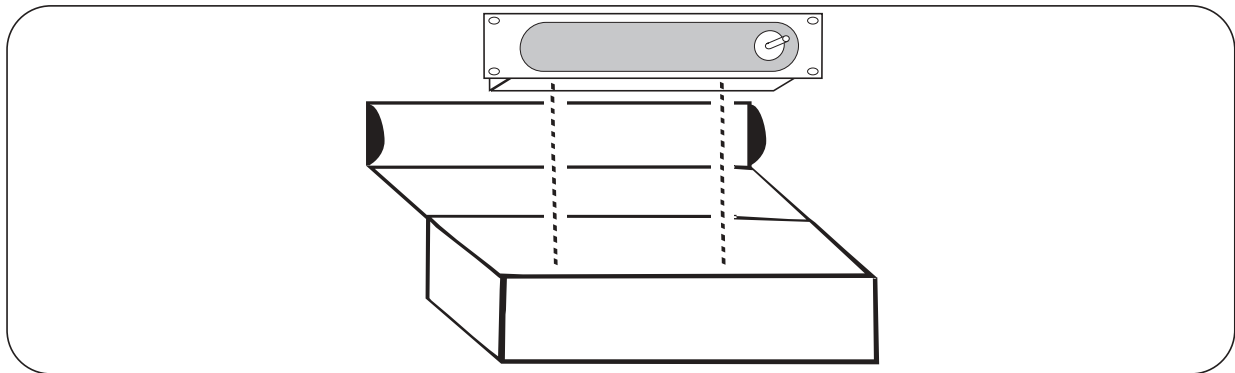

1.2 ACCESSORIES ISSUED WITH THE EQUIPMENT AND RELATIVE DOCUMENTATION

Verify the contents of the packing.

If one of the following parts of the packing is missing or damaged, please, contact your dealer immediately.

- A) User's manual
- B) AN-612 Ballast

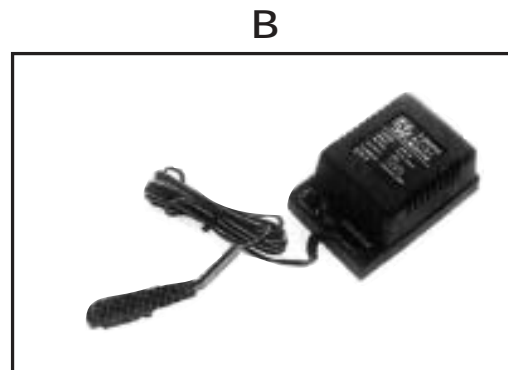
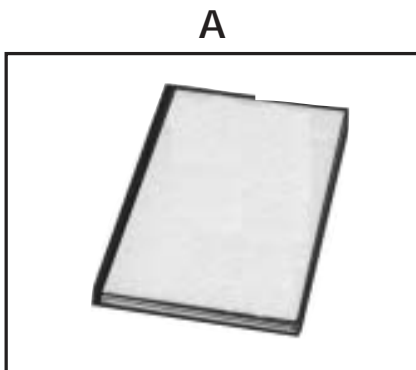

2.1 DESCRIPTION OF THE REAR PANEL AND INSTALLATION

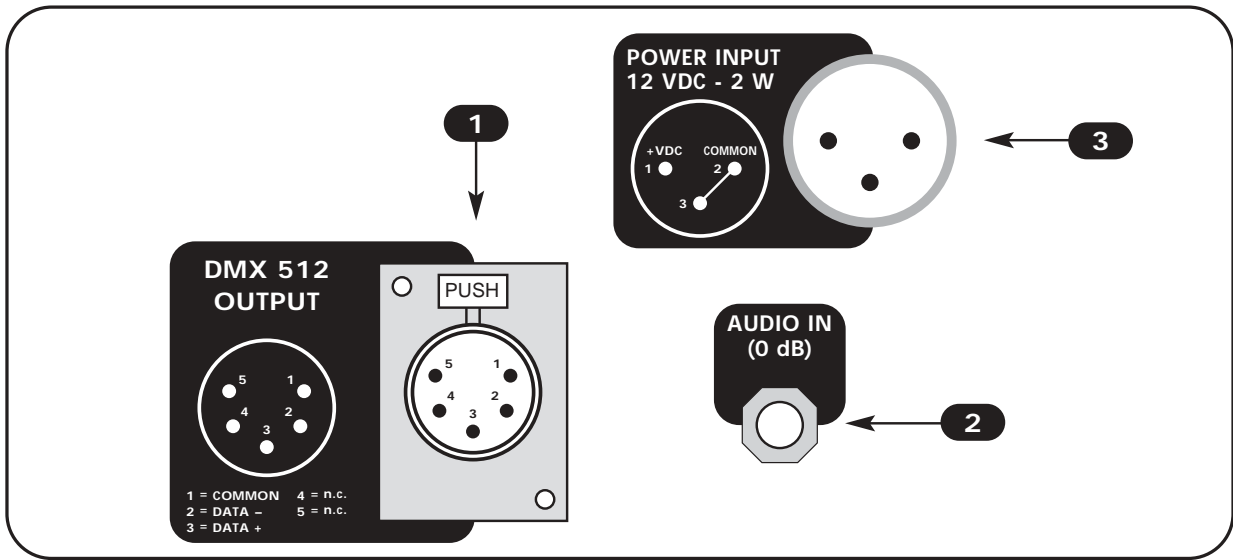

- 1** Standard DMX 512 signal OUTPUT with a 5-pin cannon connector.
- 2** 0 dB audio signal INPUT with a mono/stereo jack connector.
- 3** 12 Vdc power INPUT with a 3-pin cannon connector.

2.2 DMX 512 OUTPUT CONNECTION

Make sure you are using a shielded twisted cables suitable for the transmission of the DMX 512 signal with connectors of good quality and connection as shown on the side of the connector.

Plug the 5-pin cannon connector coming from the projectors completely in the DMX 512 output **1**

Use the “push” safety hook to disconnect it and than extract it gently.

ATTENTION: the shielded part of the cable must never be connected to the ground of the electrical system as this could cause faults during the working of the controller.

The “start” channel of the controller is channel n°1, for other DMX address you can follow the tabel below.

SCANNER N° 1	DMX address:	1
SCANNER N° 2	DMX address:	7
SCANNER N° 3	DMX address:	13
SCANNER N° 4	DMX address:	19
SCANNER N° 5	DMX address:	25
SCANNER N° 6	DMX address:	31

SCANNER N° 7	DMX address:	37
SCANNER N° 8	DMX address:	43
SCANNER N° 9	DMX address:	49
SCANNER N° 10	DMX address:	55
SCANNER N° 11	DMX address:	61
SCANNER N° 12	DMX address:	67

2.3 INPUT CONNECTION FOR POWER SUPPLY

Plug the 3-pin cannon connector of the ballast completely in the power input **3**

Use the "push" safety hook to disconnect it and extract it gently.

ATTENTION: do not use ballast different from the one supplied, it could cause serious damages at the internal circuitation.

Do not connect the 3-pin cannon connector in other appliances, it has been studied to be used only in this controller.

2.4 CONNECTION OF THE BALLAST TO THE ELECTRIC SYSTEM

MAKE SURE THAT VOLTAGE AND POWER FREQUENCY CORRESPOND TO WHAT IS REPORTED ON THE BALLAST PLATE.

The supplied ballast has a plug, therefore you should only plug it in the socket.

Press **POW** key to verify the correct installation.

If pressing the **POW** key no one led light up, please check if there is tension in the electric socket or check the connection between ballast-controller and ballast-electric socket.

If the problem persist, please consult your dealer.

3.1 PROGRAM MODE

This function allows to activate a program or a range of programs

Pressing **PROG** key the *PROGRAM* function is activated (Fig.1)

The red led of **PROG** key will light up to indicate the activation of this function.

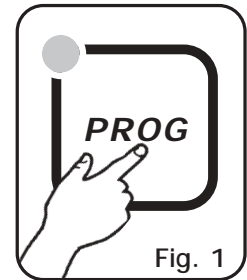

Press 1÷12 keys to activate/deactivate the programs which will be performed in succession.

All selected programs have a lighted up led, while the active program has a flashing led.

N.B. Each program is repeated for a number of times established through the *REPEAT* function (see par. 6.4)

The speed of change between the scenes can be controlled by **RATE ▲** and **RATE ▼** keys (see par. 5.1).

The relation between the movement of the scanners and the pause between scenes is controlled by **SPEED ▲** and **SPEED ▼** keys (see par. 5.2).

When the maximum or minimum speed is reached the led of the **SHIFT** key flashes.

3.2 SCENE MODE

This function allows to see one of the 12 scenes of the program in action.

N.B. If no programs are selected the **SCENE** function is not active.

Pressing **SCENE** key the *SCENE* function is activated (Fig.2)

The red led of **SCENE** key will light up to indicate the activation of this function.

When you pass from *PROGRAM* mode to *SCENE* mode, the scene active in that moment is selected.

Press any 1÷12 keys to activate/deactivate the scene.

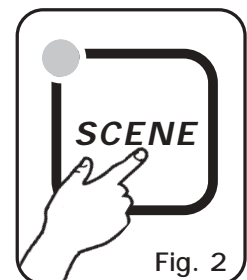

The speed of change between the scenes can be controlled by **RATE ▲** and **RATE ▼** (see par. 5.1).

When the maximum or minimum speed is reached the led of the **SHIFT** key flashes.

N.B. In this function **SPEED ▲** and **SPEED ▼** keys are not activated

3.3 *MAN+PROGRAM MODE*

This function allows to activate manually one or more scanners while the not selected ones go on performing the **PROGRAM** function.

When **PROGRAM** function is working, pressing **MAN** (Fig.3) key the **MAN+PROGRAM** function is activated.

The red led on **PROG** and **MAN** keys will light up to indicate the activation of this function.

Pressing **MAN** key once more you come back in **PROG** mode.

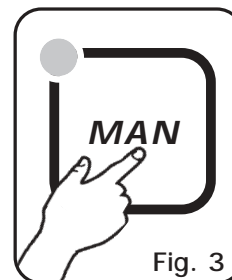

Press 1÷12 keys to activate/deactivate the scanners manually controlled.

The selected scanners (with lighted up led) do not follow anymore the program, but are manually controlled through the joystick, the selection of the channel and the slider.

Once it has been deactivated, the scanner performs again the working program.

3.4 *MAN+SCENE MODE*

This function allows to activate manually one or more scanners to create or to modify a scene.

When **SCENE** function is working, pressing **MAN** key (fig. 4) the **MAN+SCENE** function is activated.

The red led of **SCENE** and **MAN** keys will light up to indicate the activation of this function.

Pressing **MAN** key once more you can come back to the **SCENE** mode.

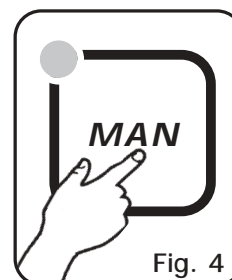

Pressing one of the 1÷12 keys the scanner manually controlled is activated. To select more scanners press in sequence 1÷12 keys very quickly. The selected scanners (with lighted up led) can be manually controlled using the joystick, the channel selection and the slider.

Once another scanner has been selected, the previous one keeps all made sets.

4.1 DESCRIPTION OF THE FRONT PANEL

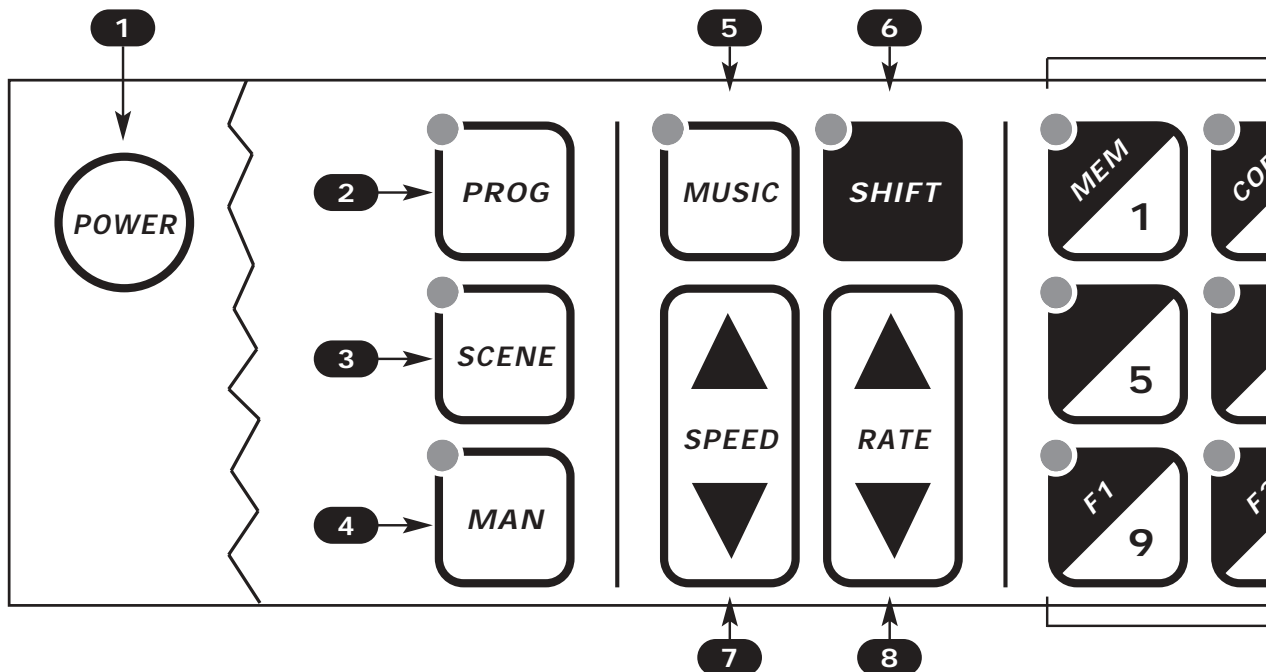

- 1** To activate /deactivate the controller storing all the data.
- 2** To activate the PROGRAM mode.
- 3** To activate the SCENE mode.
- 4** To activate the PROG+MAN / SCENE+MAN function.
- 5** To activate the MUSIC function for the change of the scene to the beat of the music.
- 6** To activate the SHIFT function and select the second function of 1/12 keys.
- 7** To increase / reduce the SPEED value.
- 8** To increase / reduce the RATE value.
- 9** To select a program / scene / scanner depending on the working function.

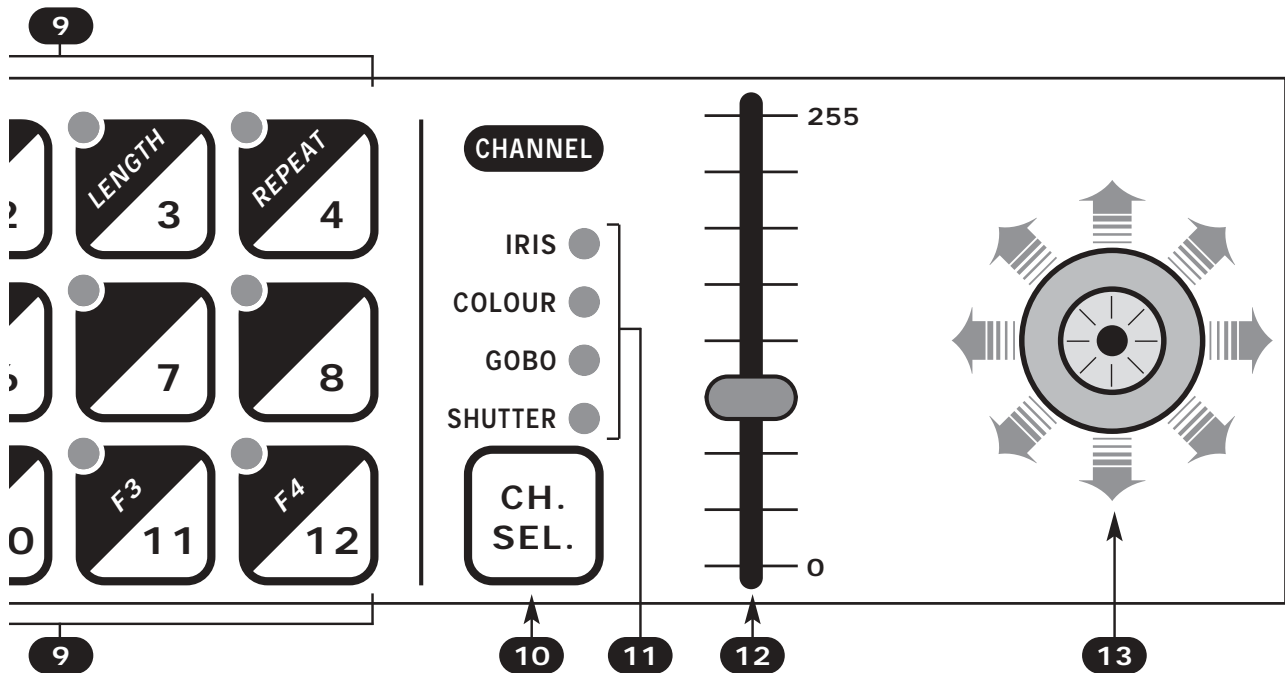

- 10** To select the channel on which the slider should operate.
- 11** It shows the channel on which the slider is operating.
- 12** Slider: it changes the value from 0 to 255 of the selected channel.
- 13** Joystick: it allows an easy positioning of the scanners.

5.1 ADJUSTMENT OF THE RATE SPEED

The adjustment of the **RATE** is activated only in *PROG* and *SCENE* function. The two settings of the value are independent as passing from one mode to the other you find the same previous set value.

The **RATE** value is simply the time that the scene takes to arrive at the end, therefore it is also the speed of the change between the scenes.

Using the **RATE ▲** key (Fig.5) the speed increases, i.e. the scene takes less time to arrive at the end position, while using the **RATE ▼** key (Fig.5) the speed reduces up to a value of 30 seconds to end the scene.

When the maximum and minimum speed is reached the led on the **SHIFT** key flashes.

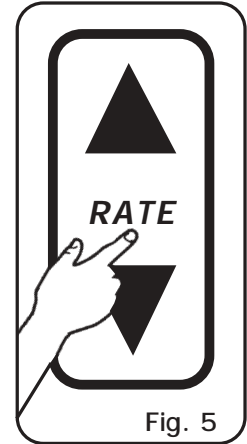

Fig. 5

5.2 ADJUSTMENT OF THE SPEED

The **SPEED** adjustment is activated only in *PROG* function, while it is deactivated in *SCENE* and *MUSIC* function.

The **SPEED** value is the ratio between the time of the scanner's movement and the total length of the scene.

The **SPEED** value are 10: from 10% to 100%.

Using the **SPEED ▲** key (Fig.6) the speed increases and the time of pause, too, while using the **SPEED ▼** key (Fig.6) the speed reduces and the movement becomes continuous, without pauses.

For instance, if you set a **RATE** of 30 seconds and the **SPEED** has the minimum value, the scene has a length of 30 seconds and the movement of the mirror has a length of 30 seconds, too. If you set the previous **RATE** value but you increase the **SPEED** value up to 50%, the length of the scene is always 30 seconds instead the movement of the mirror has a length of 15 seconds (as the speed is doubled in comparison with the previous one) and a pause of 15 seconds.

When the maximum and minimum speed are reached the led on the **SHIFT** key flashes.

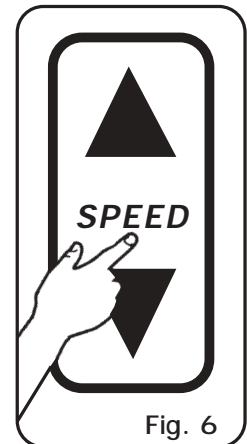

Fig. 6

5.3 ADJUSTMENT OF THE X AND Y CHANNELS THROUGH THE JOYSTICK

Using the joystick the X and Y channels of the scanner's mirror can be adjusted (Fig.7).

The type used is the one with the return in the centre which allows an easy and exact positioning thanks to the sophisticated software of management, too.

The movement is a proportional type, i.e. if you keep the joystick in central position the mirror keeps still; whereas the more you move it away from the centre the more the movement of mirror increases.

To make a movement of a step it will be enough to give some small strokes to the joystick in the desired direction.

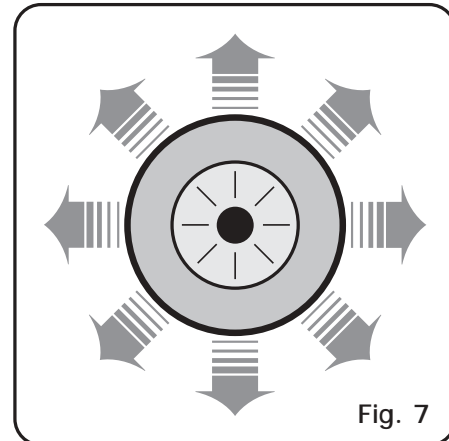

THE CONTROLLER WORK WITH PAN AND TILT ON THE CHANNELS 5 AND 6

To modify the assignment of the pan and tilt on the channels 1 and 2 perform this procedure:

-Hold pressed the **1** key and turn on the controller through **Power** key at the same time.
Now the Joystick work with the channels **1 and 2**.

To modify the assignment of the pan and tilt on the channels 5 and 6 perform this procedure:

-Hold pressed the **5** key and turn on the controller through **Power** key at the same time.
Now the Joystick work with the channels **5 and 6**.

5.4 ADJUSTMENT OF THE IRIS - COLOUR - GOBO - SHUTTER CHANNELS

The adjustment of the 4 channels is made with only one slider (Fig.8).

The value of the slider is connected with the channel which is selected through the **CH.SEL.** key and it is indicated by the leds on the key (Fig.9).

To change the channel on which the slider is working press one or more times the **CH.SEL.** key till the led of the desired channel lights up.

N.B. Every time you change channel the previous value of each channel is not modified till you do not move the slider.

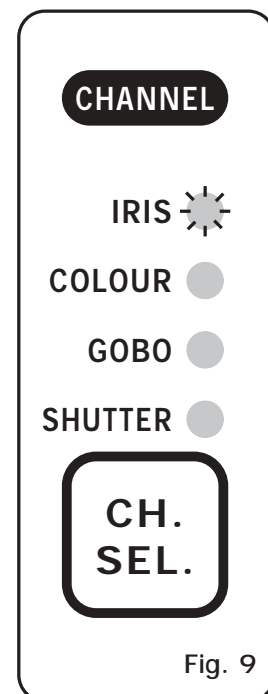
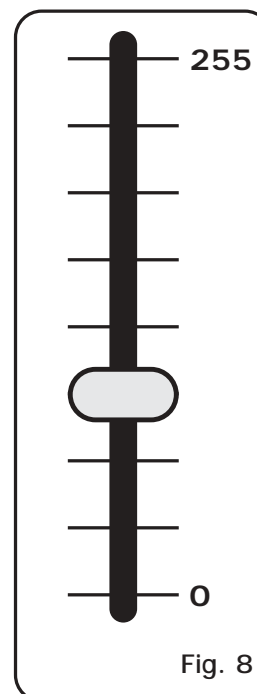

5.5 MUSIC FUNCTION

This function performs the program to the rhythm of the music, synchronising the change of the scene with the bass beats.

Pressing the **MUSIC** key (Fig.10) the **MUSIC** function is activated.

This function can be activated only during the **PROGRAM** and **MAN+PROGRAM** mode.

The green led on the key lights up to indicate the starting of this function.



Using this function the change of the scenes occurs only when the musical sensor receives the audio signal from the rear audio input or from the built-in microphone. (If to the rear input you connect a jack the built-in microphone is deactivated).

The speed of the change between the scenes is controlled by the **RATE ▲** and the **RATE ▼** keys: when the max or mi speed is reached the led on the **SHIFT** key flashes.

Usually, during the **MUSIC** function, the speed of the change between the scenes should be not so low otherwise the movement of the scanner will be very slow. The internal music sensor has an automatic gain adjustment which allows to have a signal level good for the controller's working. The input music signal is a 0dB mono/stereo so it could be taken from sound sources like Mixer, CD, Dat etc.

N.B. In this function the **SPEED ▲** and the **SPEED ▼** keys are deactivated.

Only one channel of the jack stereo connector placed on the rear of the controller is connected to the music sensor.

IT IS ABSOLUTELY FORBIDDEN TO CONNECT TO THIS INPUT ANY POWER SIGNALS FOR ACOUSTIC SPEAKER COMING FROM AMPLIFIED MIXER OR AMPLIFIER!!

5.6 BLK function (blackout)

This function reset the color and the gobo channels in all the scanners.

This function can be activated only during the **PROGRAM** and **MAN+PROGRAM** mode.

To activate the **BLK** function you have to activate the **second function of the keys** pressing once the **SHIFT** key (Fig.11). (a yellow led on the **SHIFT** key lights up).

Then press **12/BLK** key (Fig.12).

Now, the led on the **12/BLK** key is flashing and all the function of the controller are off.

Only pressing again the **12/BLK** key the controller return to it's normal functions.



6.1 MEM FUNCTION

.....
THIS FUNCTION IS AVAILABLE ONLY IN **MAN** MODE
.....

This function stores in a scene the present situation of the scanners.

To activate the **MEM** function you have to activate the **second function of the keys** pressing once the **SHIFT** key (Fig.11).
(a yellow led on the **SHIFT** key lights up).

If the led on the **SHIFT** key does not light up, the **MEM** function cannot be activated as no scene has been selected previously.

Then press **1/MEM** key (Fig.12).

Now, the settings of the channels and the X and Y position of all scanners are stored in a permanent way in the selected scene of the active program (see par. 7.1).

If all the operations have been done correctly, the mode of working pass from **MAN** mode to **SCENE** mode so that any other scene can be selected, created or modified.

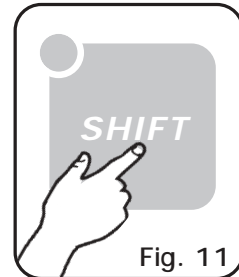

Fig. 11

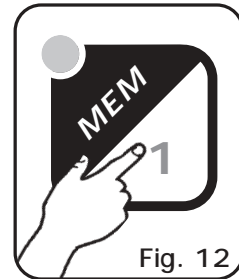

Fig. 12

6.2 COPY FUNCTION

.....
THIS FUNCTION IS AVAILABLE ONLY IN **SCENE** MODE
.....

This function allows to copy the present active scene in another one.

To activate the **COPY** function you have to activate the **second function of the keys** pressing once the **SHIFT** key (Fig.13).
(a yellow led on the **SHIFT** key lights up).

If the led on the **SHIFT** key does not light up, the **COPY** function cannot be activated as no scene has been selected previously.

Then press **2/COPY** key (Fig.14).

Now, the led of the active scene is flashing; press any 1÷12 keys to select the scene of destination.

Pressing a different key the copy function is cancelled.

If all the operations have been done correctly, the active scene becomes now the scene of destination.

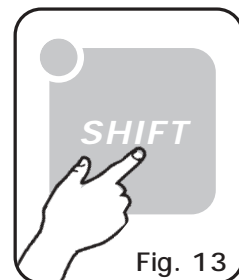

Fig. 13

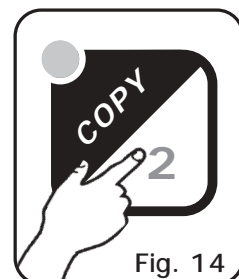

Fig. 14

6.3 LENGTH FUNCTION

.....
THIS FUNCTION IS AVAILABLE ONLY IN *PROG* MODE
.....

This function allows to choose the length of the active program, or rather the last performed scene of the program.

To activate the **LENGTH** function you have to activate the **second function of the keys** pressing once the **SHIFT** key (Fig.15). (a yellow led on the **SHIFT** key lights up).

If the led on the **SHIFT** key does not light up, the **LENGTH** function cannot be activated as no program has been selected previously.

Then press **3/LENGTH** key (Fig.16).

Now, the led of the the selected length is flashing; press any 1÷12 keys to select a new length of the program.

Pressing a different key the operation is cancelled.

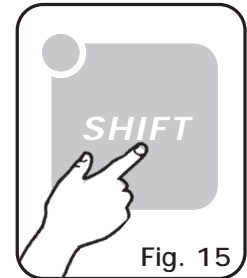

Fig. 15

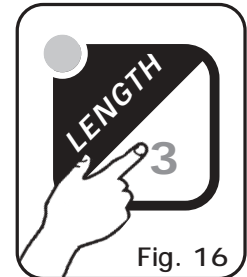

Fig. 16

6.4 REPEAT FUNCTION

.....
THIS FUNCTION IS AVAILABLE ONLY IN *PROG* MODE
.....

This function allows to select the number of repetitions for each program.

To activate the **REPEAT** function you have to activate the **second function of the keys** pressing once the **SHIFT** key (Fig.17). (a yellow led on the **SHIFT** key lights up).

If the led on the **SHIFT** key does not light up, the **REPEAT** function cannot be activated as no program has been selected previously.

Then press **4/REPEAT** key (Fig.18).

Now, the led corresponding with the selected number of repetitions is flashing; press any 1÷12 keys to select a new value.

Pressing a different key the operation is cancelled.

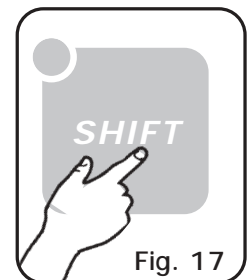

Fig. 17



Fig. 18

7.1 EXAMPLE OF WORKING - CREATION OF A PROGRAM

A program is a range of scenes (max 12) performed in succession. To create (or to modify) a program follow all steps listed below:

- 1) If the controller is switched off, switch it on pressing **POW** key.
- 2) Press **PROG** key to activate the **PROGRAM** function.
(the red led on the same key will light up).
- 3) Using 1÷12 keys select only the program that you want to modify.
(only one program is flashing).
- 4) Press **SCENE** key to activate the **SCENE** function.
(the red led on the same key will light up).
- 5) Using 1÷12 keys select the scene that you want to modify.
- 6) Press **MAN** key to activate the **MAN+SCENE** function.
(the red leds on the **MAN** and **SCENE** keys will light up).
- 7) Using 1÷12 keys select one or more scanners and modify the position with the joystick and the sets of the channels with the **CH.SEL.** key and the slider.
- 8) Once the scanners have been selected and the scene has been completed, it can be stored using the **MEM** function: press **SHIFT** key and than **1/MEM** key (see par. 6.1).
- 9) Now the controller is again in the **SCENE** function in order that you can select another scene or copy the scene already done in another one (see par. 6.2).
- 10) Once the creation of the scenes has been finished press **PROG** key to come back to the **PROGRAM** function.
(the red led on the same key will lighth up).
- 11) Finally, you should set the length of the program using the **LENGTH** function: press once **SHIFT** key than the **3/LENGTH** key followed by the number of the last stored scene (see par. 6.3).

The program is finished; to create or modify others repeat again all the above steps.

TECHNICAL FEATURES OF NAVIGATOR 612

Technical features: programming

Number of scanners controlled separately: **12**
Number of channels for each scanner: **6 (4ch. + Y + X)**
Number of stored programs: **12**
Number of scenes for each program: **12**
Total number of scenes: **144 (12 programs x 12 scenes)**
Positioning way of the mirror: **through a proportional Joystick with return.**

Technical features: output signal

Kind of output signal: **DMX512/ 1990**
Output connector: **5-pin cannon connector**
Max number of scanners connected to the DMX output: **32**
Number of DMX channels: **72 (6 ch. x 12 scanners)**

Technical features: storage of program

Kind of storage / size: **EEPROM / 128 Kbit**
Length of data maintenance without power supply: **> 40 years**
Number of entries cycles: **>100.000**

Technical features: storage of settings

Kind of storage / size: **EEPROM / 2 Kbit**
Length of data maintenance without power supply: **> 40 years**
Number of entries cycles: **>10.000.000**

Climatic condition for the use

Humidity: **35% ÷ 80%**
Temperature: **5 ÷ 50 °C**

Power supply

Voltage/current: **12 Vdc / 240 mA**

Technical fetures: audio input

Source: **Inside through a built-in microphone / outside through a stereo jack**
Sensitivity / input impedance: **0 dB (775 mV) / 50 Kohm**
Kind of level adjustment: **Automatic**

Dimensions and weight

Dimension (W x L x H) / Weight: **482 x 88 x 40 mm (2U rack) / 1,5 Kg.**

CODEM MUSIC S.r.l. - Via Del Vallo, 110 - 61100 PESARO - ITALY

Tel. +39 0721 204357- Fax +39 0721 203554

<http://www.codemmusic.com> - E-mail: info@codemmusic.com

All rights reserved. No parts of this document can be copied, photocopied or reproduced without the prior written permission of the **CODEM MUSIC** s.r.l.

No responsibility is taken for possible inaccuracies or mistakes.

The **CODEM MUSIC** s.r.l. reserves the right to make any alterations or aesthetics changes of this product that seem necessary at any time and for whatever reason.

The **CODEM MUSIC** s.r.l. takes no responsibility for the use or for the application of this product.